

Wilkhahn

Solis F.
190 range





Solis F

Design: wiege

Model 199/5

High backrest with integral headrest,
adjustable backrest height, frame coated
in the colour silver, satin finish

Solis F.

High tech with high touch.

The Solis F model group is marked by uncompromisingly purist form and an amazingly high degree of comfort. It has been designed for applications, which require a clear commitment to transparency, progress and the future. "F" stands for frame and refers to the distinct structures of the seat and backrest, which comprise two frames covered with stretch material. With Solis, sitting in "pure simplicity" becomes an impressive experience, involving all the senses.

Solis F is available in two backrest heights; the high backrest version with optional integral headrest. In addition, there are variations with a height-adjustable backrest. Leather-covered pads are standard for the Solis F armrests and headrest.



The design of the seat and backrest is both fascinating and comfortable: the two vertical profiles are tautly stretched by the curved horizontal braces in die-cast aluminium.

High-quality, detachable leather-covered cushions are available to meet demands for a high degree of prestige.



Simply consistent –
simply comfortable.



The black fabric is stretched across the profiles, making it highly elastic in the upper and lower sections. This allows the backrest to adjust automatically to individual body shapes. At the same time, the ergonomically shaped frame profiles ensure active pelvic support in the seat and correct lumbar support in the backrest. Solis F thus marks a perfect combination of technical aesthetics and healthy sitting.

The fascination of technical materials and their precise workmanship, the reduction of forms to their functional sense and purpose, and transparency that reveals everything – this interplay characterizes Solis F like no other office chair. Even the armrests and the headrest consist of rectangular aluminium profiles, which are visibly attached to the frame structure.

The highly comfortable sitting experience is even more remarkable: the synchro-mechanism, opening to a wide angle, allows the seat front to lower automatically. This mechanism harmonizes perfectly with the qualities of the transparent, high-performance material, which is attached to the lateral frame profiles.

Solis F.

Models and features.

Solis F

Function

Swivel chairs with automatic synchro-adjustment: seat and backrest angle adjusts automatically to sitting position of user. When leaning back, backrest tension increases according to need for additional support. Seat platform lowers at the front synchronously with sequence of movement. Crank handle for infinitely variable tension adjustment for user. Seat/backrest angle lockable in eleven different positions by engaging lever. Adjustment levers and crank handle in fibre glass-reinforced polyamide, through-dyed in black-grey. Encapsulated gas lift for infinitely variable adjustment of seat height of swivel chairs. Optional adjustment of backrest height in seven positions within a range of 60 mm. Conference/visitor's chairs at fixed height with automatic synchro-adjustment.

Frame

Five-star base in die-cast aluminium, coated, polished or chromium-plated. Twin wheel swivel castors with load-dependent braking and integral protection buffer, conforming to DIN EN 12529, as standard version for carpeted floors, or with grey polyurethane soft lining for hard floors. Anti-static castors on request. Black-grey polyamide glides as standard version for carpeted floors, or with polyurethane glides for hard floors. Backrest bearer, front swivel arms, rear swivel arms, seat bearer and synchro-mechanism case in die-cast aluminium, coated in colour silver, satin finish. Synchro-mechanism cover in plastic, through-dyed in black-grey.

Seat and backrest

Seat and backrest frame comprising extruded aluminium profiles and die-cast aluminium lateral frame, coated in colour silver, satin finish. Transparent, stretch, high-performance material attached to lateral profiles of both seat and backrest frame for optimal support and ventilation. Two backrest heights; high backrest version optionally with headrest.

Headrest

Headrest, in combination with high backrest, in die-cast aluminium with cut polyurethane foam. Black leather cover.

Detachable cushions

Slim, two-section cushion with quilted leather cover.

Armrests

Armrests in die-cast aluminium, with covered cut foam. Black leather cover.

Standards

Solis F swivel chairs have been developed to conform to the Office Chair Standard DIN EN 1335, ANSI/BIFMA X 5.1 and other international office chair standards. Depending on selected features, they meet the requirements of categories A, B or C of the Office Chair Standard DIN EN 1335.

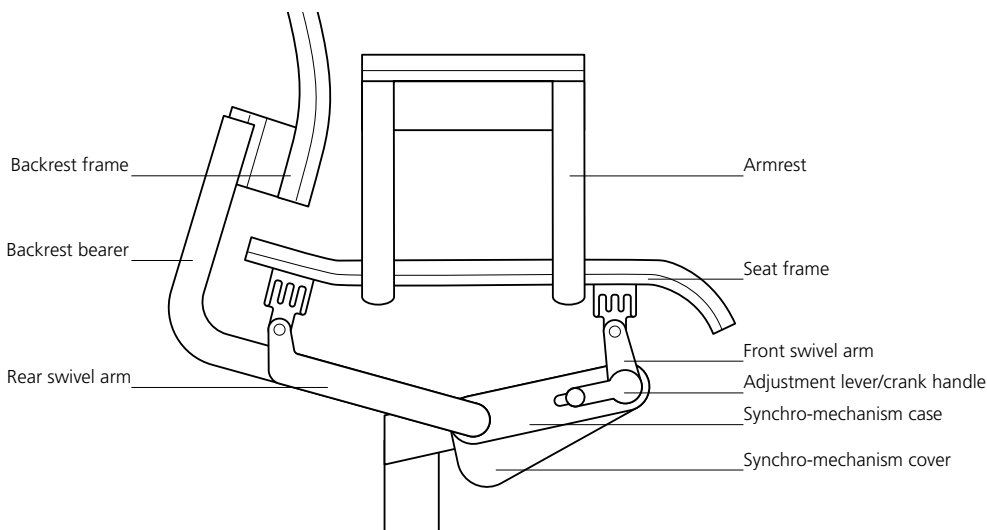

Five-star base

Coated, colour silver, satin finish
 Polished aluminium
 Chromium-plated

Seat and backrest

Seat/backrest with high-performance material
 Add. cushion for seat and backrest, black leather
 Armrests with leather pad
 Headrest with leather pad
 Adjustable backrest height

Standard height backrest

High backrest

High backrest with headrest

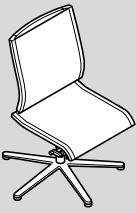

195/1



195/4

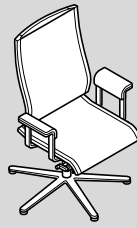

197/4



195/11



195/41



197/41

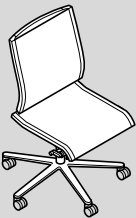

196/1

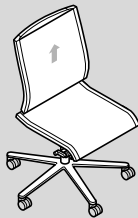

196/2



196/4



196/5

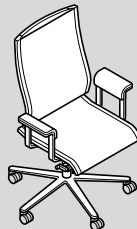

198/4

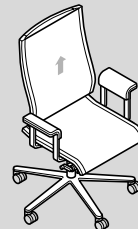

198/5

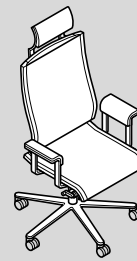

199/4

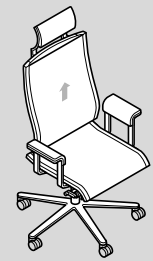

199/5



196/11



196/21



196/41



196/51



198/41



198/51



199/41



199/51

•	•	•	•	•	•	•	•
•	•	•	•	•	•	•	•
•	•	•	•	•	•	•	•
•	•	•	•	•	•	•	•
• 195/11, 196/11	• 196/21	• 195/41, 196/41	• 196/51	• 197/41, 198/41	• 198/51	• 199/41	• 199/51
		•	•	•	•	•	•
	•		•		•		•

